

**TP Series, Tiny**

**Features**

- Compact design
- Round or rectangular actuator buttons.
- Vertical or right angle versions



Pushbutton Switches

**Typical performance characteristics**

Contact configuration . . . . . SPST, SPDT, DPDT  
 Contact timing . . . . . Break-Before-Make  
 Contact rating max. . . . . gold: 0.4VA @20VDC or peak AC  
 . . . . . silver: 1A @ 125VAC or 28 VDC resistive  
 Electrical life . . . . . 1 pole2 . . .2 pole  
 . . . . . gold . . . . . 100,000 . . .80,000 cycles  
 . . . . . silver . . . . . 60,000 . . .50,000 cycles  
 Contact resistance, initial . . . . . max.20 mOhms  
 Insulation resistance . . . . . 1,000 MOhms @ 500VDC  
 Dielectric strength . . . . . 1,000 Volts rms @ sea level  
 Actuation force . . . . . 0.5 to 4N (50-400gf)  
 Actuator travel . . . . . momentary .030" (.762)

**Environmental specification**

Operating temperature . . . . . -30°C to +65°C  
 Storage temperature . . . . . -30°C to +65°C  
 Solder heat resistance . . . . . wave solder capable to 265° C

**Material specifications**

Contacts . . . . . copper or brass, gold over nickel finish or silver  
 . . . . . clad with silver over nickel finish  
 Actuator . . . . . thermoplastic  
 Terminals . . . . . brass with gold over nickel or silver over nickel  
 Case . . . . . thermoplastic  
 Frame and support bracket . . . . . steel with tin over copper finish  
 RoHS Directive 2002/95/EC . . . . . compliant

<b>Product key</b>	Typical product key		<b>TP</b>	<b>A</b>	<b>1</b>	<b>1</b>	<b>C</b>	<b>G</b>	<b>PC</b>	<b>0</b>	<b>04</b>
<b>Type</b>	Tiny pushbutton series										
<b>Bushing</b>											
<b>blank</b>	square, no bushing										
<b>A</b>	round, no bushing										
<b>B</b>	round .188 (4.78) dia. bushing not threaded										
<b>C</b>	round 10/48 UNS 2B thread										
<b>D</b>	.250" (6.35) dia. bushing, not threaded										
<b>F</b>	round 1/4-40 UNS 2B thread										
<b>Actuator</b>											
<b>blank</b>	standard										
<b>F</b>	flush (available with B and C bushings only)										
<b>Number of Poles</b>											
<b>1</b>	single pole										
<b>2</b>	double pole										
<b>Contact rating</b>											
<b>1</b>	0.4VA Gold										
<b>2</b>	1.0 A Silver (Silver available only in wire lug and PC termination)										
<b>Function</b>											
<b>single pole</b>											
<b>C</b>	single throw, momentary										
<b>F</b>	double throw, momentary										
<b>CC</b>	dual function C - 2 x single throw, momentary										
<b>FF</b>	dual function F - 2 x double throw, momentary										
<b>double pole</b>											
<b>M</b>	single throw, momentary										
<b>R</b>	double throw, momentary										
<b>Plating</b>											
<b>G</b>	Gold										
<b>blank</b>	Silver (Silver available only in wire lug and PC termination)										
<b>Terminals</b>											
<b>blank</b>	wire lug										
<b>PC</b>	printed circuit board										
<b>RA</b>	right angle										
<b>VRA</b>	vertical, right angle (available only in single pole)										
<b>Button Color</b>											
<b>0</b>	black										
<b>2</b>	red										
<b>6</b>	blue										
<b>Material</b>											
<b>04</b>	RoHS compliant										

**TP Series, Tiny (Continued)**

**Bushing**



**blank, square, no bushing**

**printed circuit board**



Single pole

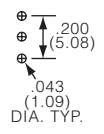
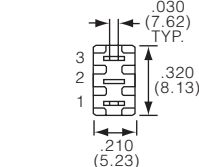
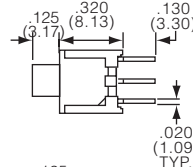
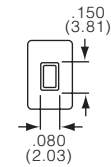

2 x Single pole (dual)

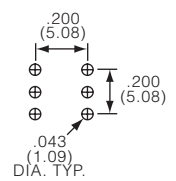
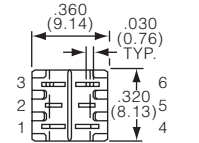
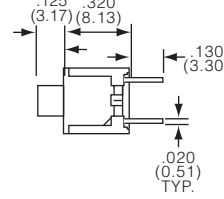
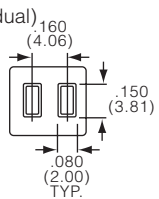

Note: no center terminal on 'C' and 'M' function switch

**right angle**



Single pole

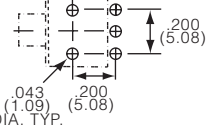
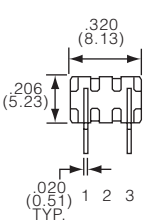
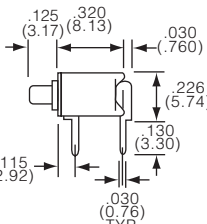
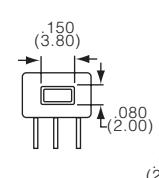

Note: no center terminal on 'C' and 'M' function switch



2 x Single pole (dual)

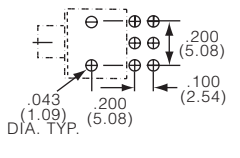
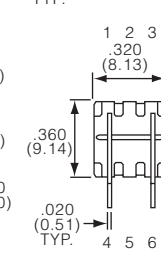
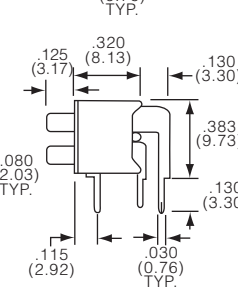
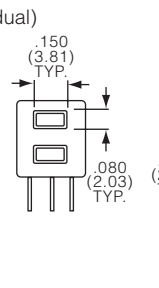

**A, Round, no bushing**

**printed circuit board**



Single pole

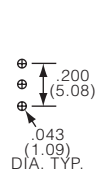
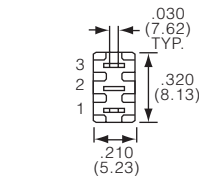
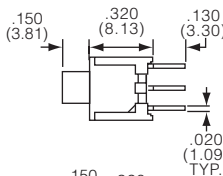
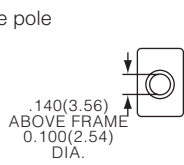

2 x Single pole (dual)

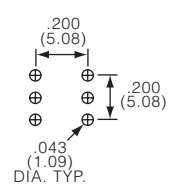
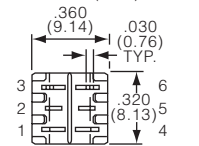
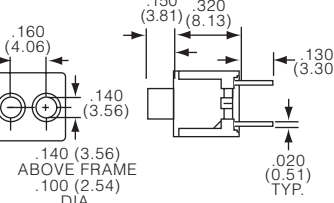
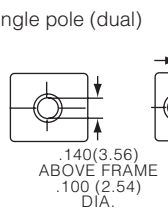

Note: no center terminal on 'C' function switch

**TP Series, Tiny (Continued)**

**right angle**



Single pole

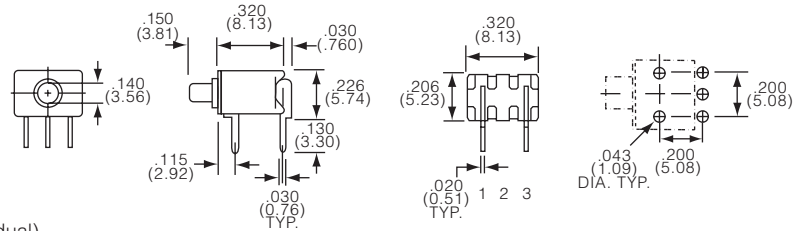

2 x Single pole (dual)

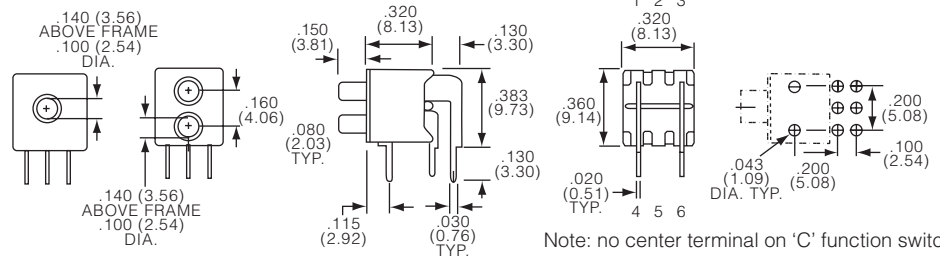

Note: no center terminal on 'C' function switch

**B, Round .188 (4.78) dia. bushing not threaded**

**printed circuit board**

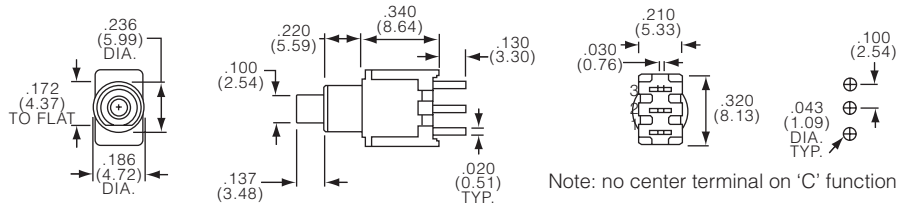

Note: no center terminal on 'C' function switch

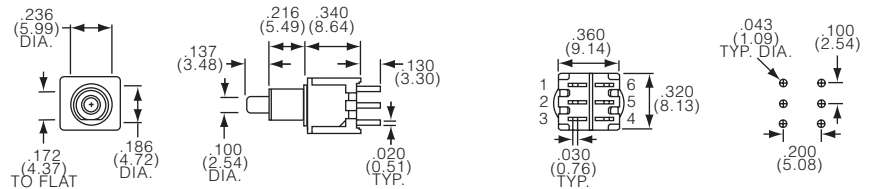

Note: no center terminals on 'M' function switch

**right angle**

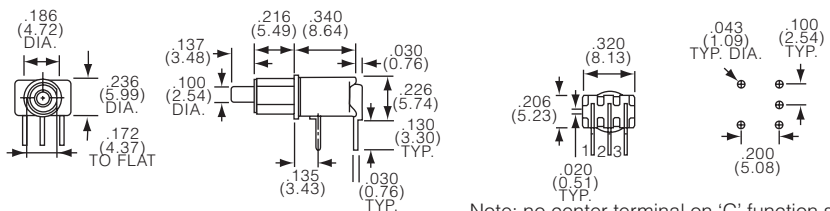

Note: no center terminal on 'C' function switch

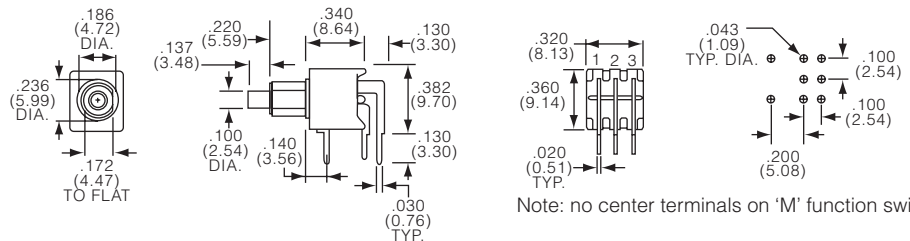

Note: no center terminals on 'M' function switch

**TP Series, Tiny (Continued)**

**vertical right angle**

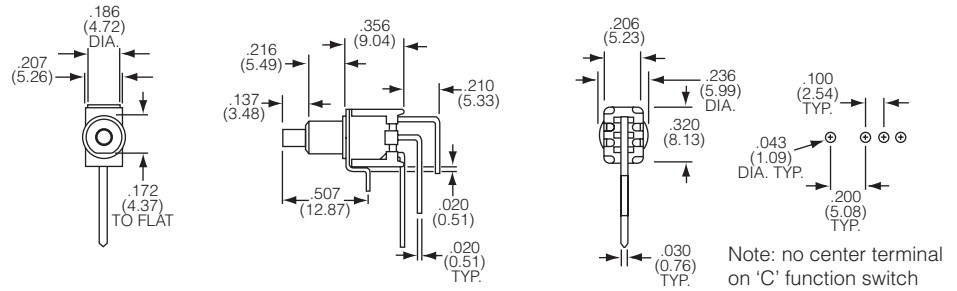

**printed circuit board, flush actuator**

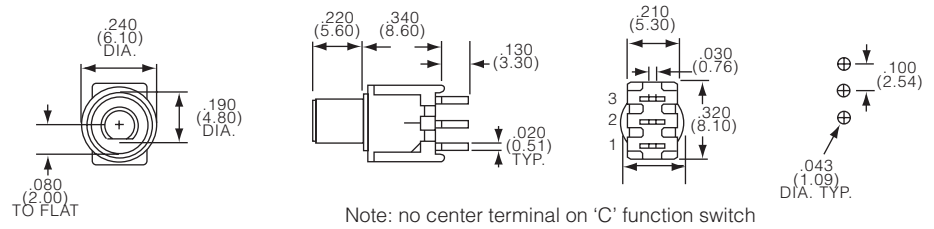

**right angle, flush actuator**

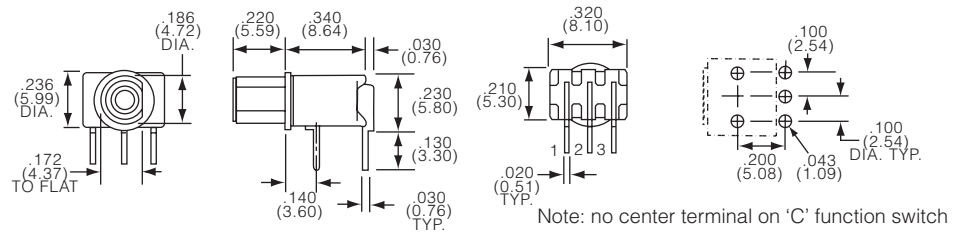

**C, Round 10/48 UNS 2B thread**

**wire lug**

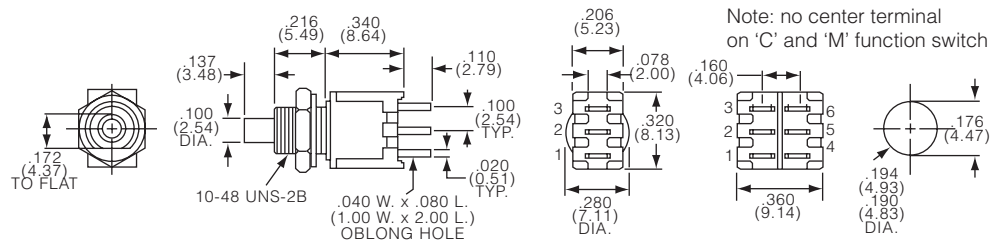

**printed circuit board**

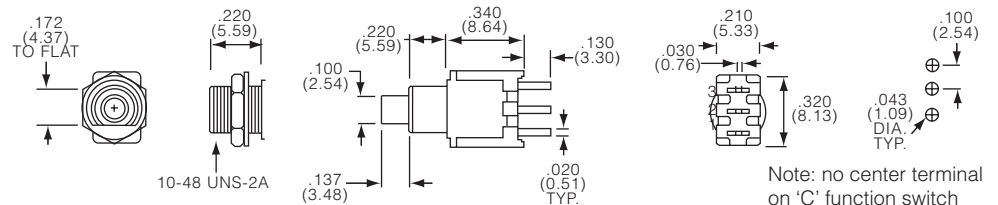

Pushbutton Switches

**TP Series, Tiny (Continued)**

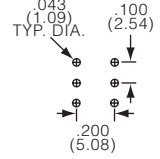
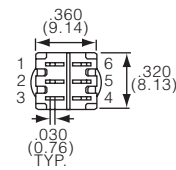
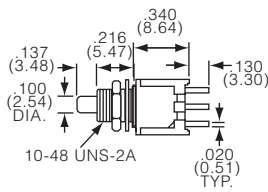

Note: no center terminals on 'M' function switch

**right angle**

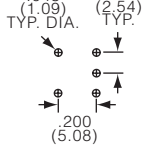
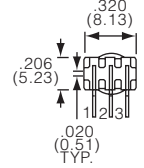
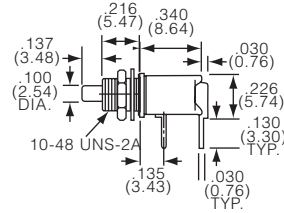

Note: no center terminal on 'C' function switch

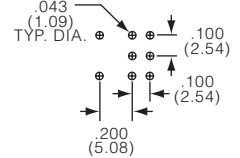
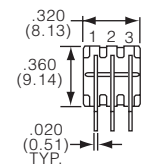
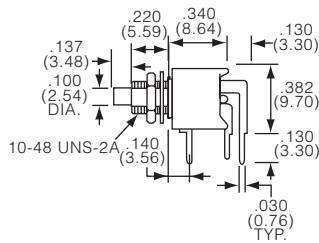

Note: no center terminals on 'M' function switch

**vertical right angle**

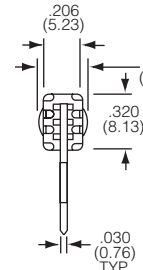
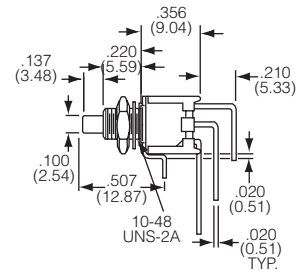
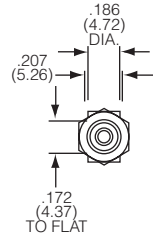

Note: no center terminal on 'C' function switch

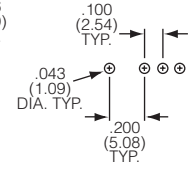

**wire lug, flush actuator**

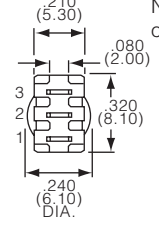
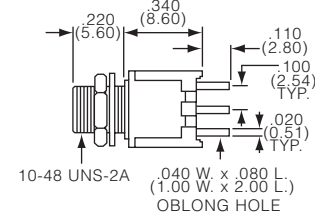
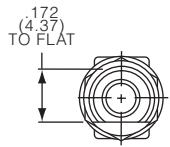

Note: no center terminal on 'C' function switch

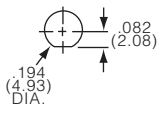

**printed circuit board, flush actuator**

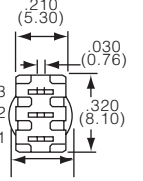
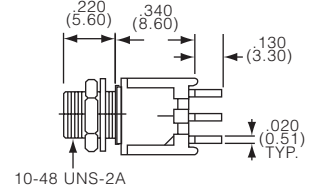
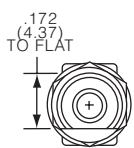

Note: no center terminal on 'C' function switch

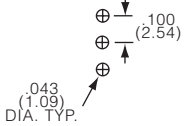

**TP Series, Tiny (Continued)**

**right angle, flush actuator**

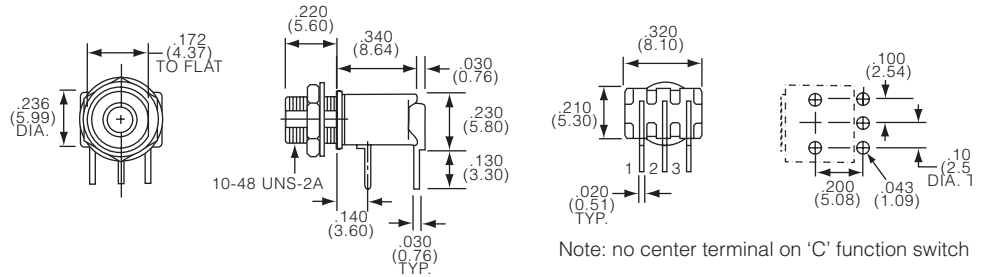

**D, .250" (6.35) dia. bushing, not threaded**

**printed circuit board**

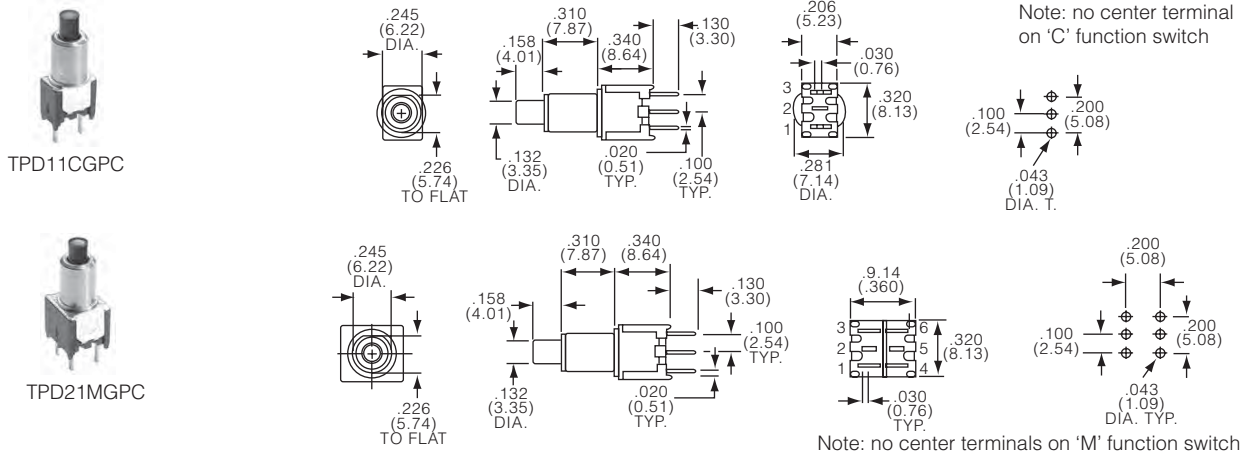

**right angle**

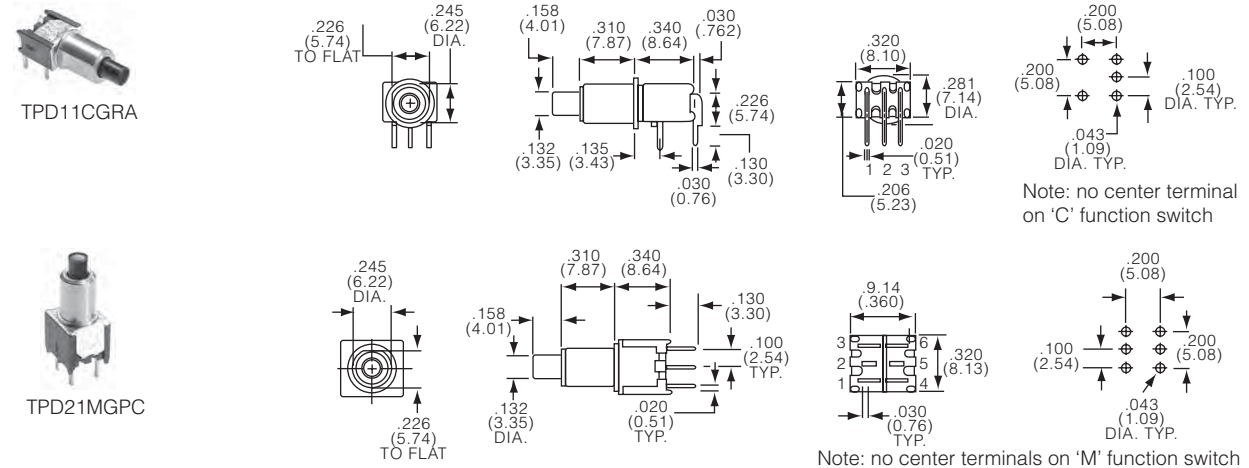

**TP Series, Tiny (Continued)**

**F, Round 1/4-40 UNS 2B thread**

**wire lug**

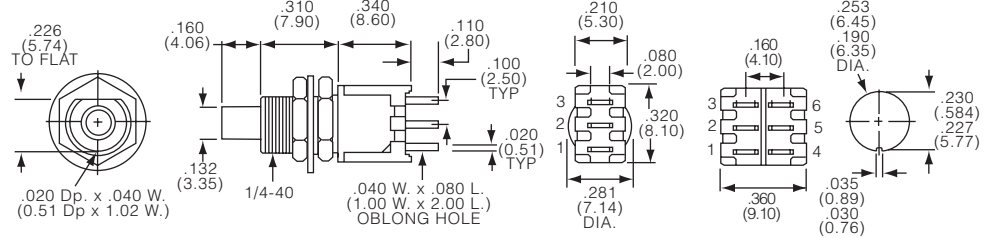

Note: no center terminal on 'C' and 'M' function switch

**printed circuit board**

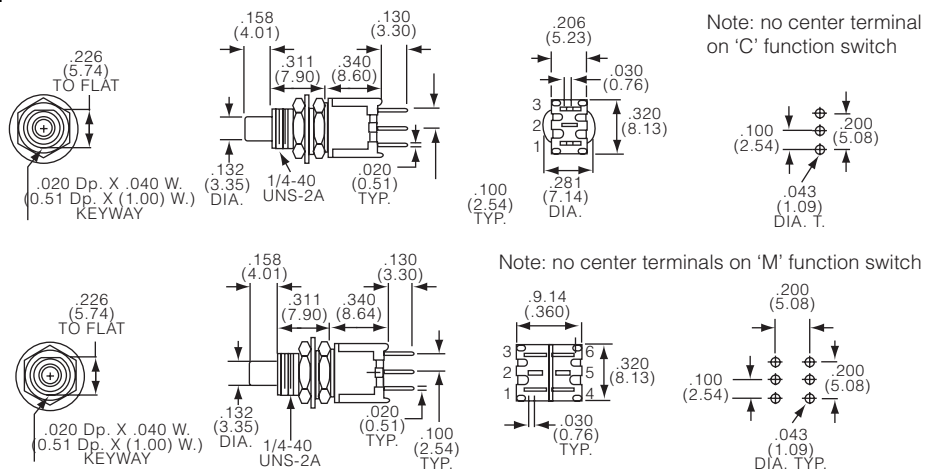

Note: no center terminal on 'C' function switch

Note: no center terminals on 'M' function switch

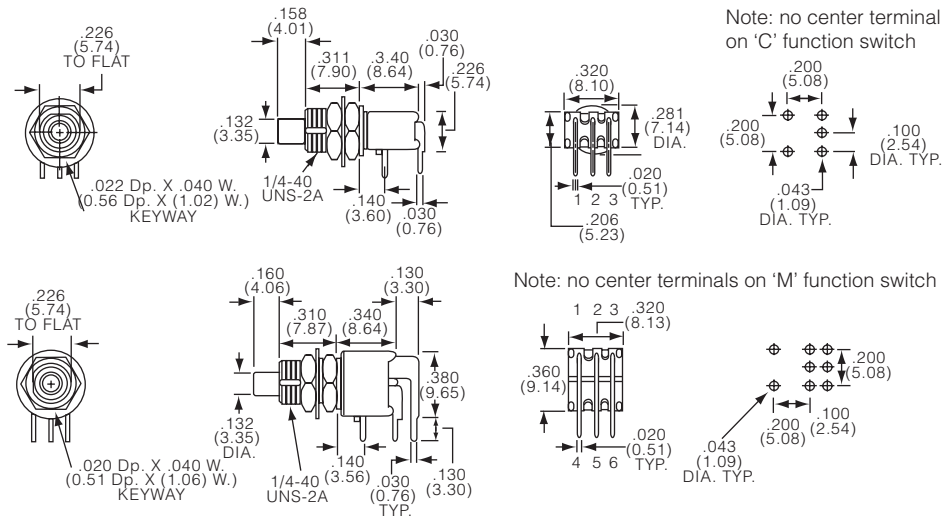

**right angle**



Note: no center terminal on 'C' function switch

Note: no center terminals on 'M' function switch

**TP Series, Tiny (Continued)**



Product key	Bushing	Act.	Poles	Rating	Function			Plating	Terminals	Btn.	Material	Part Number
TP11CGPC004	square	n/a	1	0.4VA	Off-(On)	Off	1-3	Gold	pcb	black	RoHS	1825095-1
TP11CGPC204	no bushing									red	compliant	1825095-2
TP11CGRA004									right angle	black		1825095-3
TP11CGRA204										red		1825095-4
TP11CGRA604										blue		1825095-5
TP11FGPC004					On-(On)	1-2	2-3		pcb	black		1825095-6
TP11FGPC204										red		1825095-7
TP11FGRA004									right angle	black		1825095-8
TP11FGRA204										red		1825095-9
TP11FGRA604										blue		1-1825095-0
TP21CCGRA004			2 (1+1)		Off-(On)	Off	1-3			black		1-1825095-1
TP21CCGRA204										red		1-1825095-2
TP21FFGRA004					On-(On)	1-2	2-3			black		1-1825095-3
<b>TPA11CGPC004</b>	round		1		Off-(On)	Off	1-3		pcb			<b>1825096-1</b>
TPA11CGPC204	no bushing									red		1825096-2
TPA11CGPC604										blue		1825096-3
<b>TPA11CGRA004</b>									right angle	black		<b>1825096-4</b>
TPA11CGRA204										red		1825096-5
TPA11CGRA604										blue		1825096-6
<b>TPA11FGPC004</b>					On-(On)	1-2	2-3		pcb	black		<b>1825096-7</b>
TPA11FGPC204										red		1825096-8
TPA11FGPC604										blue		1825096-9
<b>TPA11FGRA004</b>									right angle	black		<b>1-1825096-0</b>
TPA11FGRA204										red		1-1825096-1
TPA11FGRA604										blue		1-1825096-2
TPA21CCGPC004			2 (1+1)		Off-(On)	Off	1-3, 4-6		pcb	black		1-1825096-3
TPA21CCGRA004									right angle			1-1825096-4
TPA21FFGRA204					On-(On)	1-2, 4-5	2-3, 5-6			red		1-1825096-5
TPA21MGRA004			2		Off-(On)	Off	1-3, 4-6			black		1-1825096-6
<b>TPB11CGPC004</b>	round	std	1				1-3		pcb			<b>1825097-1</b>
TPB11CGPC204	.188 (4.78)									red		1825097-2
<b>TPB11CGRA004</b>	dia								right angle	black		<b>1825097-6</b>
TPB11CGRA204	bushing,									red		1825097-4
TPB11CGVRA004	not								vertical r.a.	black		1825097-8
<b>TPB11FGPC004</b>	threaded				On-(On)	1-2	2-3		pcb			<b>1825097-9</b>
<b>TPB11FGRA004</b>									right angle			<b>1-1825097-1</b>
TPB11FGRA204										red		1-1825097-2
TPB11FGRA604										blue		1-1825097-3
TPB11FGVRA004									vertical r.a.	black		1-1825097-6
<b>TPB21MGPC004</b>			2		Off-(On)	Off	1-3, 4-6		pcb			<b>1-1825097-7</b>
TPB21MGPC204										red		1-1825097-8
TPB21MGRA004									right angle	black		2-1825097-8
TPB21RGRA004					On-(On)	1-2, 4-5	2-3, 5-6					1-1825097-9
TPB21RGRA0EDC04												1825112-1
TPBF11CGRA004		flush	1		Off-(On)	Off	1-3					2-1825097-1
TPBF11FGRA004					On-(On)	1-2	2-3					2-1825097-4
TPBF11FGRA204										red		2-1825097-5

Preferred parts in bold print



**TP Series, Tiny (Continued)**

Pushbutton Switches

Product key	Bushing	Act.	Poles	Rating	Function			Plating	Terminals	Btn.	Material	Part Number
TPC11CGPC004	round	std	1	0.4VA	Off-(On)	Off	1-3	Gold	pcb	black	RoHS compliant	1825098-1
TPC11CGRA004	10/48								right angle			1825098-2
TPC11CGRA204	UNS 2B									red		1825098-3
TPC11CGVRA004	thread								vertical r.a.	black		1825098-4
TPC11FGPC004					On-(On)	1-2	2-3		pcb			1825098-5
TPC11FGRA004									right angle			1825098-6
TPC11FGVRA004									vertical r.a.			1825098-7
TPC11FGVRA204										red		1825098-8
TPC13C004				1.0 A	Off-(On)	Off	1-3	Silver	wire lug	black		1825098-9
TPC13C204										red		1-1825098-0
TPC13CPC004									pcb	black		1-1825098-1
TPC13F004					On-(On)	1-2	2-3		wire lug			1-1825098-2
TPC21MGRA204			2	0.4VA	Off-(On)	Off	1-3, 4-6	Gold	right angle	red		1-1825098-3
TPC21RGPC004					On-(On)	1-2, 4-5	2-3, 5-6		pcb	black		1-1825098-4
TPC23M004				1.0 A	Off-(On)	Off	1-3, 4-6	Silver	wire lug			1-1825098-5
TPC23R204					On-(On)	1-2, 4-5	2-3, 5-6			red		1-1825098-6
TPCF11CGPC004		flush	1	0.4VA	Off-(On)	Off	1-3	Gold	pcb	black		1-1825098-7
TPCF11CGRA004									right angle			1-1825098-8
TPCF11FGRA004					On-(On)	1-2	2-3					1-1825098-9
TPCF13C004				1.0 A	Off-(On)	Off	1-3	Silver	wire lug			2-1825098-0
TPCF13F004					On-(On)	1-2	2-3					2-1825098-1
TPD11CGPC004	.259 (6.35)	n/a		0.4VA	Off-(On)	Off	1-3	Gold	pcb			1825099-1
TPD11CGPC204	dia									red		1825099-2
TPD11CGRA004	bushing,								right angle	black		1825099-3
TPD11CGRA204	not									red		1825099-4
TPD11CGRA604	threaded									blue		1825099-5
TPD11FGPC004					On-(On)	1-2	2-3		pcb	black		1825099-6
TPD11FGRA004									right angle			1825099-7
TPD11FGRA204										red		1825099-8
TPD21MGRA004			2		Off-(On)	Off	1-3, 4-6			black		1825099-9
TPD21RGPC004					On-(On)	1-2, 4-5	2-3, 5-6		pcb			1-1825099-0
TPF11CGPC004	round		1		Off-(On)	Off	1-3					1825100-1
TPF11CGPC204	1/4-40									red		1825100-2
TPF11CGRA004	UNS 2B								right angle	black		1825100-4
TPF11CGRA204	thread									red		1825100-5
TPF11CGRA604										blue		1825100-6
TPF11FGPC004					On-(On)	1-2	2-3		pcb	black		1825100-7
TPF11FGPC204										red		1825100-8
TPF11FGPC604										blue		1825100-9
TPF11FGRA004									right angle	black		1-1825100-1
TPF13C004				1.0 A	Off-(On)	Off	1-3	Silver	wire lug			1-1825100-2
TPF13C204										red		1-1825100-3
TPF13F204					On-(On)	1-2	2-3					1-1825100-4
TPF13F604										blue		1-1825100-5
TPF21MGPC004			2	0.4VA	Off-(On)	Off	1-3, 4-6	Gold	pcb	black		1-1825100-6
TPF21RGRA004					On-(On)	1-2, 4-5	2-3, 5-6		right angle			1-1825100-7
TPF23M004				1.0 A	Off-(On)	Off	1-3, 4-6	Silver	wire lug			1-1825100-8